



# Cabinetry Care Guide

## Care and Cleaning

### Wood and Veneer Door Styles

Once your cabinets have been installed, wipe down all exteriors and interiors with a damp cloth to remove dust, drying immediately with a dry cloth. Be careful not to scratch the surface when wiping off dust and debris.

- Regular exterior and interior cleaning requires only wiping with a damp cloth and then drying. Remove oil, grease or general soil using a clean cloth dampened with a fresh solution of mild soap and water. Rinse with a clean, damp cloth, then dry thoroughly. It is important to wipe spills immediately. Prolonged exposure to spills, including food, water or other liquids can cause permanent discoloration or damage to your cabinet's finish.
- Avoid using harsh detergents, strong soap, abrasive cleaners or self-polishing waxes. All of these items can damage the factory-applied protective finish.
- Avoid using your dishcloth to clean or dry cabinet exteriors. It may contain remnants of detergents and grease.
- Immediately dry surfaces where water may have spilled using a clean cloth. Never hang damp towels over cabinetry to dry. Excessive moisture will cause the wood to expand and damage the finish. Treat your cabinets as you would fine furniture and they will reward you with long-lasting beauty.

### Thermofoil Door Styles

#### REGULAR CARE AND CLEANING

- Always use a cotton cloth or non-abrasive sponge.
- Wipe with a damp cloth or sponge with mild dish soap or a 50/50 mix of water and Simple Green® (which also works well on oily or tacky surfaces).

#### CLEANING OF STAINS (INFREQUENT CARE)

- Always use a cotton cloth or non-abrasive sponge.
- Using a damp cloth or sponge with a 50/50 mix of water and Simple Green®, scrub lightly for 10 to 20 strokes. This should remove most stains.

- If stain persists, use a damp cloth or sponge with Buckeye Workout®, standard Fantastik® (S.C. Johnson), or standard Formula 409® (The Clorox Co.), lightly wipe for 10 to 20 strokes. Buckeye Workout is a commercial cleaner and readily available from a local distributor (to locate call 314-291-1900).

**NOTE:** Buckeye Workout contains water and propylene glycol phenyl ether.

- If stain persists further, place a cloth or sponge damp with 70% Isopropyl Alcohol on top of the stain for 30 minutes. After 30 minutes, remove the cloth or sponge and wipe. This should remove makeup, ball-point ink, and other stubborn stains. Repeat this step until stain is removed.

#### DISINFECTING THERMOFOIL SURFACES

Bleach (a 10% mixture) or Quat cleaner can be used as a disinfectant on most thermofoil surfaces. Before using on an entire surface, be sure to test on a non-visual spot.

#### CLEANERS TO AVOID

- Any abrasive cleaner.
- Most solvent based cleaners and harsh chemicals such as sink and toilet bowl cleaners.
- Any cleaner in combination with a brush.
- Cleaners containing ammonia.
- Baking soda.

If a harsh chemical is spilled on a thermofoil surface, wipe it up immediately. Then wash the surface with soapy water and rinse several times.

#### PRODUCT LIMITATIONS

Thermofoil products are not intended for use as cutting surfaces; always use a cutting board. Do not place hot pans from a stove directly onto the surface. This product is also not intended for use in exterior applications.

- High heat generated from self-cleaning cycles of ovens or ranges may discolor thermofoil cabinetry; we recommend using heat shields or opening your doors and drawers fully when using the self-cleaning cycle.

## Care and Cleaning (continued)

### Acrylic and Thermofoil Gloss Finishes

High gloss surfaces become more scratch resistant over the first few days after the protective film is removed. This process can be accelerated by lightly polishing the surface immediately after the protective film is removed using Ultra-Gloss Superpolish + DGS, Novus 1 Polish, or Plexus Plastic Cleaner with a clean microfiber cloth. Ultra-Gloss Superpolish + DGS can be purchased from SSI North America. Call 973-598-0152 to order. See websites below to order the other care products.

- [www.novuspolish.com](http://www.novuspolish.com)
- [www.plexusplasticcleaner.com](http://www.plexusplasticcleaner.com)

#### CLEANING

Best results will be achieved using wet micro-fiber cloths or chamois with mild soap and water. Never dry wipe the acrylic finish. Applying Ultra-Gloss Superpolish + DGS, Novus 1 Polish, or Plexus Plastic Cleaner on a weekly basis will maintain the acrylic finish in an optimum condition.

- Avoid harsh household cleaners and abrasives.
- Always check the active ingredients of your cleaners to be sure there are no potentially harmful chemicals. Do not use acetone, chloroform, benzene, ammonia, thinners, caustic soda, toluene, xylene, dichloromethane, amylacetate, glacial acetate acid, butyl alcohol, butyl acetate, cellusolve, cresols/phenols, ethylacetate, chlorinated solvents, halogenated solvents, methyl alcohol, methyl ethyl ketone.
- Acpi is not responsible for any damage done by abrasive cleaning products or procedures.

#### OTHER CLEANERS TO AVOID

- Any abrasive cleaner.
- Paper towels, brushes, scourers or scrapers.
- Most solvent based cleaners and harsh chemicals such as sink and toilet bowl cleaners.

#### HANDLING

- Leave protective film in place until the project is complete.
- Do not store panels outside.
- Do not store or transport panels in direct sunlight.
- Avoid sliding the panels on the outer face surface.

### Decorative Hardware

Periodically use mild soap and warm water to clean door and drawer hardware.

- After cleaning, dry and buff hardware with a clean, soft cloth.
- Do not use brass and silver polishes. These polishes contain harsh chemicals that can damage the hardware's surface.

### Art Glass Door Inserts

If your kitchen cabinetry includes doors with art glass inserts with zinc coming, please follow these cleaning guidelines:

- Use a dry, clean soft cloth or paper towel.
- A mild dish soap and water mixture, warm water and damp Mr. Clean® Magic Eraser® or non-abrasive glass cleaner may be used.
- Do not apply too much pressure to the glass surface. Inserts are fragile and can be easily broken with undue pressure.
- If using a spray cleaner, test on the backside of insert to make sure the cleaner does not remove the patina. It is best to use cleaner on the glass surfaces only.
- Avoid spraying cleaner directly on the glass as overspray may cause damage to wood finishes.
- Do not use any type of abrasive cleaner or Scotch-Brite™ product for cleaning as this will damage the finish of the insert.

### Glass Door Inserts

If your kitchen cabinetry includes doors with glass inserts, please follow these cleaning guidelines:

- Spray an ammonia-free glass cleaner on a clean, soft, lint-free cloth or paper towel.
- Avoid spraying cleaner directly on the glass as overspray may cause damage to wood finishes.

### Metal Doors

- Use soap or mild detergent and warm water to clean aluminum and glass.
- DO NOT use an abrasive cloth to clean aluminum or glass.
- Avoid spraying cleaner directly on aluminum or glass, apply the soap or mild detergent to a soft damp cloth.

### Breadboard Cleaning

Before initial use, wipe entire board with mineral oil and allow it to soak into wood.

- After routine use, wipe clean with a damp cloth and dry thoroughly.
- Do not immerse breadboard in water or clean in dishwasher.

## Care and Cleaning (continued)

### Cleaning Melamine TSS Surfaces

The melamine surfaces are the most resistant among those used in the furniture field. In case of persistent or dry stains, it is recommended to use water, soapy water or ethylic alcohol and acetone according to the table, below:

#### Smooth or slightly embossed surfaces

- It is recommend that you avoid spraying products directly onto the surface, as this may leave stains and marks; instead, apply the detergent product on a soft damp cloth, clean the surface and then rinse it.
- Avoid using abrasive products, bleach or highly chlorinated products or acids.

#### Deeply embossed surfaces

- Clean with a soft cloth using the aforementioned solvents, according to the table, below.
- In case of deep surfaces (such as Matrix, Orion, Nadir...) and very light colors, the aforementioned cleaning procedure may be insufficient to remove the dirt from the furrows of the deep surfaces. In this case, it is recommended to delicately clean that area, by using a melamine magic sponge: wet the sponge with tepid water and squeeze it.
- Avoid using abrasive sponges, as they may damage the surface.
- Upon request, a cleaning kit including a mild detergent and a magic sponge may be sent by CLEAF to interested customers.

	COLD WATER	COLD WATER AND DETERGENT FOR DOMESTIC USE	HOT WATER AND DETERGENT FOR DOMESTIC USE	ALCOHOL 50%	ACETONE
FRUIT JUICE, MARMALADE, SYRUP, MILK, TEA, COFFEE, LIQUEURS, WINE, SOAP, INK	X				
FATS, SAUCES, DRY BLOOD STAINS, WINE AND LIQUEURS, EGGS		X			
JELLY, CARBON BLACK, VINYL GLUE, WATERCOLORS, ORGANIC WASTE			X		
VEGETABLE OIL, PENS, MAGIC MARKERS, MAKE-UP, HAIR SPRAY				X	X
NAIL POLISH, LINSEED OIL					X

# Wood Characteristics and Humidity Control

The beauty of finished cabinetry comes from the unique natural characteristics of the wood itself.

All hardwoods have their own “personality” and characteristics; variations in color, grain pattern and texture are to be expected because they are natural aspects of the materials. Due to these naturally occurring characteristics, each piece of wood will react differently to the finish material used resulting in slight shade differences within and between cabinets.

Finished wood is constantly “mellowing” and changing in appearance because of the natural aging of wood, finish on wood and long-term effects of light. These characteristics are apparent when natural light or tinted finishes are applied. This results from the character and beauty of natural wood and are considered desirable aspects.

## Humidity in the Home

Home maintenance and medical experts advise homeowners to monitor and control indoor humidity levels in order to maintain a safe and healthy home environment. As it turns out, humidity levels that are healthiest for people are also ideal for cabinetry. Indoor relative humidity levels of 40 to 50 percent are ideal; uncontrolled extremes above 80 percent or below 20 percent are likely to cause problems.

## Humidity Imbalance

- Wood products absorb moisture and swell or expand with high humidity conditions.
- Wood products release moisture and shrink or contract with low humidity conditions.
- Some expansion or contraction of wood products may be noticeable when cabinetry is moved from one location to another or humidity conditions change.

Wood Species	Panel Size with Nominal Humidity (70°F, 45% RH)	Panel Size with Low Humidity (70°F, 20% RH)	Panel Size with High Humidity (70°F, 70% RH)	Panel Size Change from Low to High RH (70°F, 20% to 70%)
Knotty Alder	24	-0.246	0.283	0.528
Cherry/Rustic Cherry	24	-0.238	0.274	0.512
Hickory	24	-0.395	0.454	0.848
Maple/Rustic Maple	24	-0.339	0.390	0.729
Oak	24	-0.354	0.407	0.762
QS Oak	24	-0.152	0.174	0.326

- As you can see from this chart, wood’s response to humidity can be dramatic and affect the finish and/or function of cabinetry. What can be done to prevent this? Steps can be taken to balance humidity in the home.

## Steps to Balance Humidity

- Consistently run heating, cooling and humidification systems to provide proper balance.
- Check outside drainage to ensure moisture is properly routed away from the home.
- Conduct an insulation audit to ensure all areas are properly insulated and vapor barriers are properly installed.
- Check with local contractors, HVAC specialists or county extension services for tips on how to achieve balance between adequate ventilation and moisture levels to maintain proper humidity levels in all seasons.

## Wood Product and Humidity Considerations

- Expansion and contraction of cabinetry most likely results from improper humidity conditions during site storage, installation or use.
- Raw or finished wood reacts to changes in humidity levels. Our multi-step finishing process slows expansion or contraction, but cannot prevent it. Small lines in the finish may appear at joinery points if cabinetry is exposed to unstable humidity levels.
- Some remodeling or construction activities greatly increase moisture content within a home and can be harmful to cabinetry if precautions are not taken. For example, drywall taping adds a lot of moisture into a home if not properly ventilated.
- Homeowners in humid climates should be especially vigilant about maintaining proper indoor humidity level.
- Regardless of location, products installed in non-air conditioned homes are susceptible to moisture imbalance. Winter and vacation homes should maintain climate control year round.
- Examples of humidity imbalance include swollen doors or drawer fronts, butt doors which no longer close properly, door and drawer front panel expansion or contraction, joint separation especially in mitered doors and bowing of stiles or rails.
- Mitered doors need low, stable moisture.
- Density of wood affects humidity levels. Hardwoods will expand or contract more than softer species.
- Cabinetry stored in unfavorable conditions should be allowed to acclimate to the surrounding environment for a period of time. This minimizes the degree wood doors may swell and bind upon installation. Once doors have been installed in controlled climate conditions they will naturally restore to original dimensions.

## Humidity and Warranty

- Warranties are written with the expectation that product will be stored and installed in a climate controlled environment; the warranty is void if cabinetry is stored or installed in extreme temperatures or humidity levels.
- Trimming swollen doors voids the warranty.
- With proper maintenance of humidity levels, new cabinetry will be a long-lasting, durable and beautiful enhancement to any home.

## Hardware Adjustments — Framed Cabinetry

### Drawer Adjustments

#### UNDERMOUNT DRAWER GUIDE ADJUSTMENT

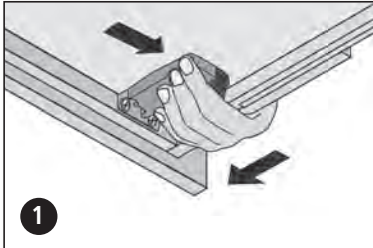

**Drawer Box Removal:** Squeeze both handles and pull drawer out and up.

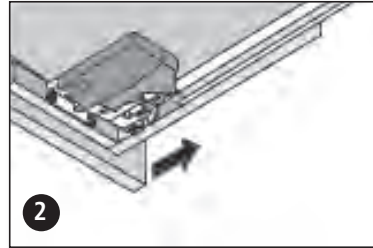

**Drawer Box Placement:** Place drawer box on runners and close; drawer will automatically engage runners.

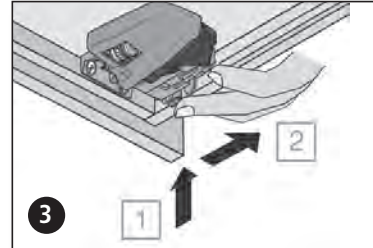

**Vertical Adjustment of Drawer Front (Version 1):** Press up on adjustment latch and slide forward or backwards. To raise drawer, slide towards back of cabinet; to lower, slide towards front of cabinet.

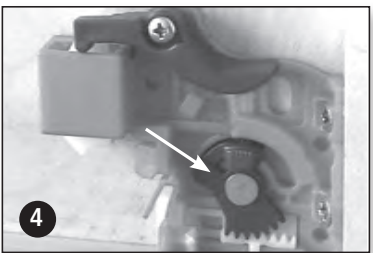

**Vertical Adjustment of Drawer Front (Version 2):** Turn wheel to achieve height adjustment for drawers with this feature.

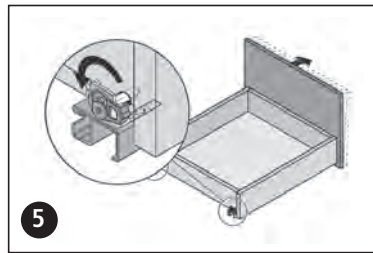

**For Drawer Guides with Tilt Adjustment:** Rotate adjustment lever on rear of each guide to adjust tilt of drawer front.

#### INSET CABINETY

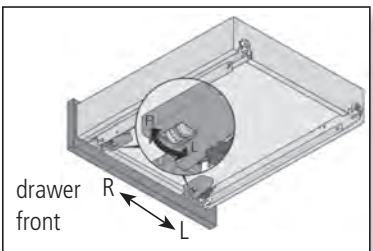

**Side Adjustment:** Rotate side adjustment left or right equally on both locking devices. Drawer front moves in same direction as rotation.

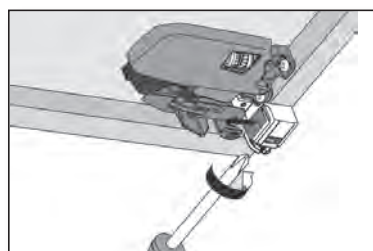

**New depth adjustable locking device:** Turning the adjustment screw allows for up to a +2.5 mm (3/32") out adjustment.

# Hardware Adjustments — Framed Cabinetry (continued)

## Door Adjustments

### OVERLAY HINGE

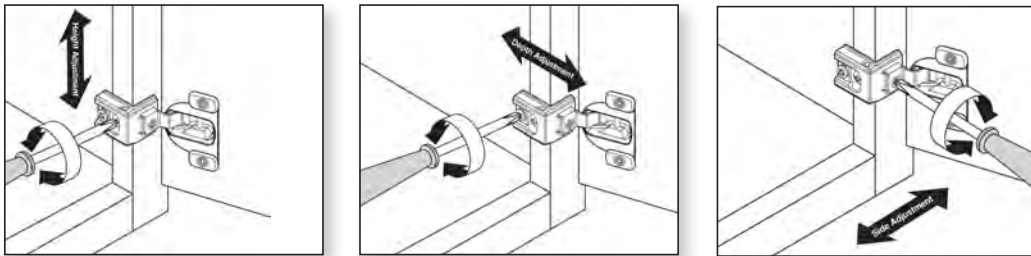

### CONCEALED HINGE (Inset)

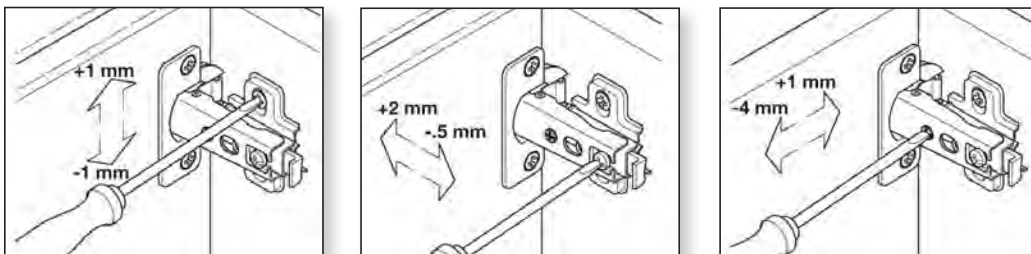

### BARREL HINGE (Inset)

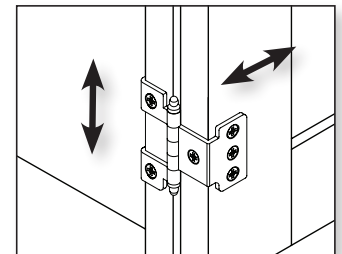

### VERTICAL, BI-FOLD LIFT AND LIFT & STAY DOOR TENSION ADJUSTMENT

Using a screw gun and a #2 x 2 POZI driver bit, adjust lift mechanism to desired tension. Test door and repeat until desired function is achieved.

**NOTE:** Tension adjustment should be the same on both lift mechanisms.



*POZI drive bits*

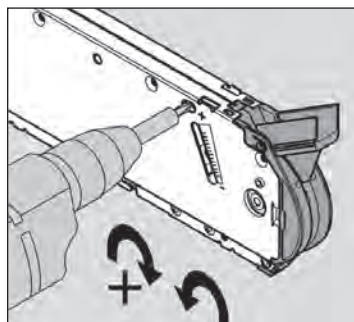

### DOOR CLOSURE

#### Quiet Close switch on hinge cup:

For small or light doors, Quiet Close can be deactivated on one of the hinges. Door must be closed once for deactivation to be complete. To reactivate, move switch back to original position.

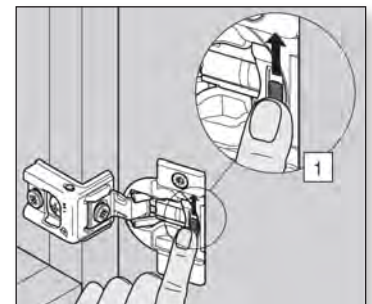

### VERTICAL LIFT DOOR TENSION ADJUSTMENT

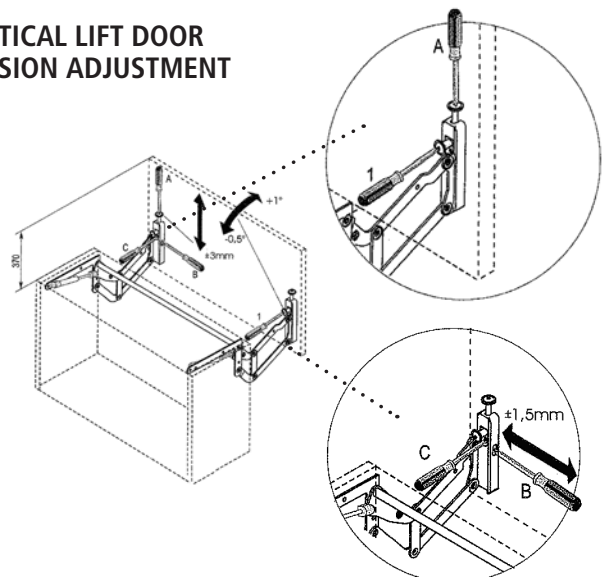

## Hardware Adjustments — Frameless Cabinetry

### Drawer Adjustments

#### UNDERMOUNT DRAWER GUIDE ADJUSTMENT

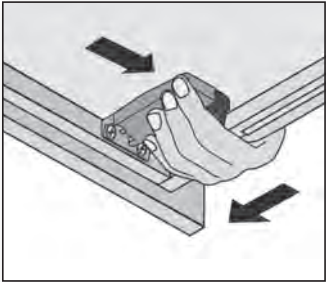

**Drawer Box Removal:**  
Squeeze both handles and pull drawer out and up.

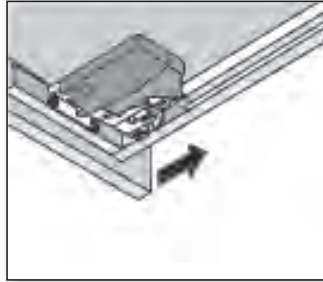

**Drawer Box Placement:**  
Place drawer box on runners and close; drawer will automatically engage runners.

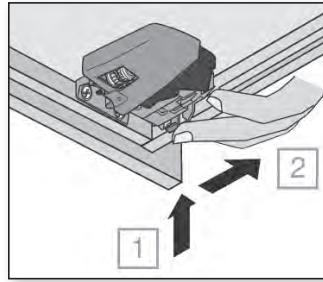

**Vertical Adjustment of Drawer Front:**  
Press up on adjustment latch and slide forwards or backwards. To raise drawer, slide towards back of cabinet; to lower, slide towards front of cabinet.

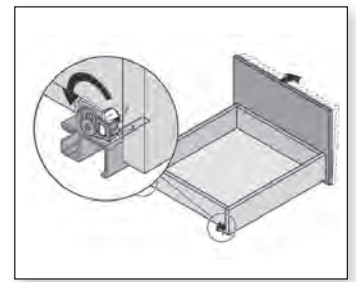

**For Drawer Guides with Tilt Adjustment:**  
Rotate adjustment lever on rear of each guide to adjust tilt of drawer front.

#### INTIVO DRAWER BOX ADJUSTMENTS

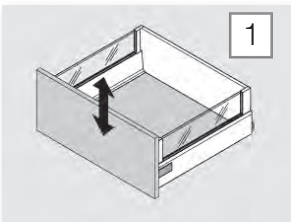
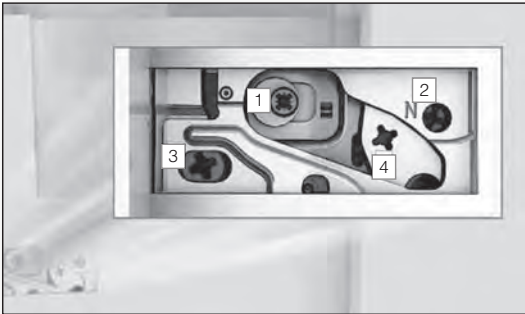

Height Adjustment

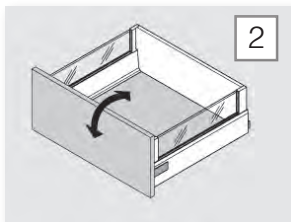

Tilt Adjustment

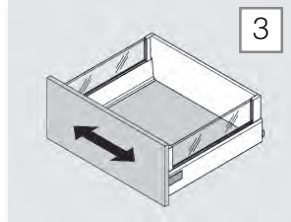

Side Adjustment

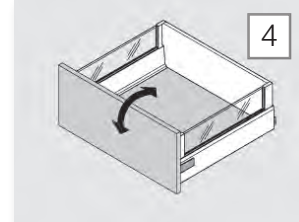

To Remove Front

# Hardware Adjustments — Frameless Cabinetry (continued)

## Door Adjustments

### CONCEALED CLIP-TOP HINGE ADJUSTMENTS

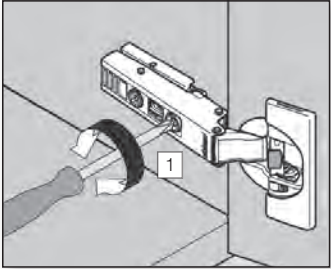

**Door overlay adjustment:**  
Rotate screw #1 to increase or decrease door overlay (+or-2 mm).

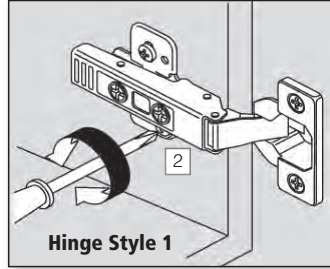

**Door height adjustment:**  
Rotate cam screw on mounting plate #2 to adjust door position (+or-2 mm).

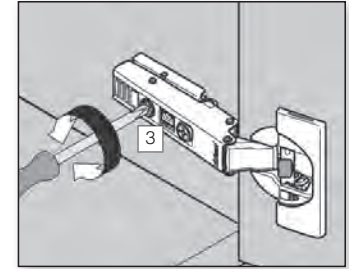
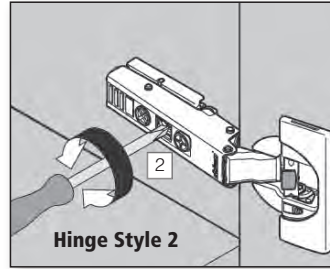

**Door depth adjustment:**  
Rotate rear spiral tech cam screw #3 to adjust door gap (+3mm,-2 mm).

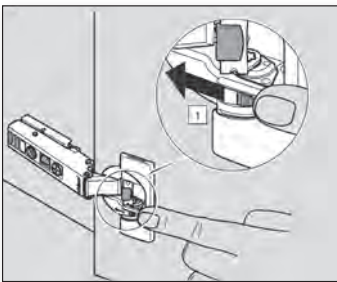

**Quiet Close switch on hinge cup:**  
For small or light doors, the Quiet Close can be deactivated on one of the hinges. Door must be closed once for deactivation to be complete. To reactivate, move switch back to original position

### VERTICAL, BI-FOLD LIFT AND LIFT & STAY DOOR TENSION ADJUSTMENT

Using a screw gun and a #2 x 2 POZI driver bit, adjust the lift mechanism to the desired tension. Test door and repeat until desired function is achieved.

**NOTE:** Tension adjustment should be the same on both lift mechanisms.

